

DATE:	PROJECT:	TYPE:
-------	----------	-------

CATALOG NUMBER LOGIC:



\*Lamp details available on the 3rd page.

\*\*The 360SL cost is already included in the price of UPM, UPM dual, and Power Canopy.

<b>CATALOG NUMBER LOGIC</b>
Example: B - DS - MR - 359 - BZP - 9 - 11 - A - 360SL
<b>MATERIAL</b>
(Blank) - Aluminum B - Brass
<b>SERIES</b>
DS - Delta Star
<b>SOURCE</b>
MR - MR16 Lamp
<b>LAMP TYPE</b>
0 - MR16 Halogen Lamp (Furnished by others)
MR16 LED (This choice requires lamp number selection)*
<b>FINISH (See page 2 for full-color swatches)</b>
Standard Finishes (BZP, BZW, BLP, BLW, WHP, WHW, SAP, VER)
Premium Finish (ABP, AMG, AQW, BCM, BGE, BPP, CAP, CMG, CRM, HUG, NBP, OCP, RMG, SDS, SMG, TXF, WCP, WIR)
Also available in RAL Finishes
Brass Finishes (MAC, POL, MIT)
<b>LENS TYPE</b>
9 - Clear (Standard)
10 - Spread    12 - Soft Focus    13 - Rectilinear
<b>SHIELDING</b>
11 - Honeycomb Baffle
<b>CAP STYLE</b>
A - 45°
B - 90°
C - Flush Lens
D - 45° Less Weephole (Interior use only)
E - 90° Less Weephole (Interior use only)
F - 90° with Flush Lens
<b>OPTIONS</b>
360SL - Knuckle Mounting System**

DATE:

PROJECT:

TYPE:

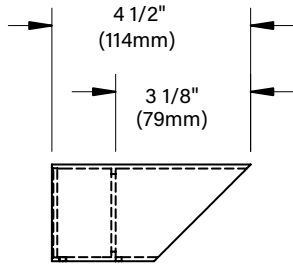
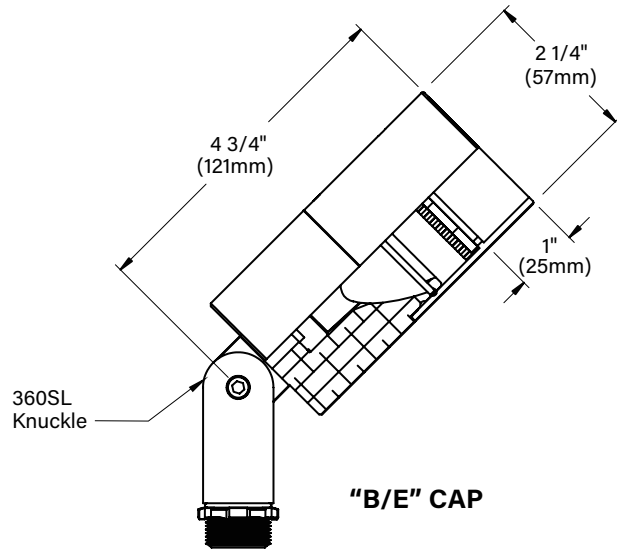
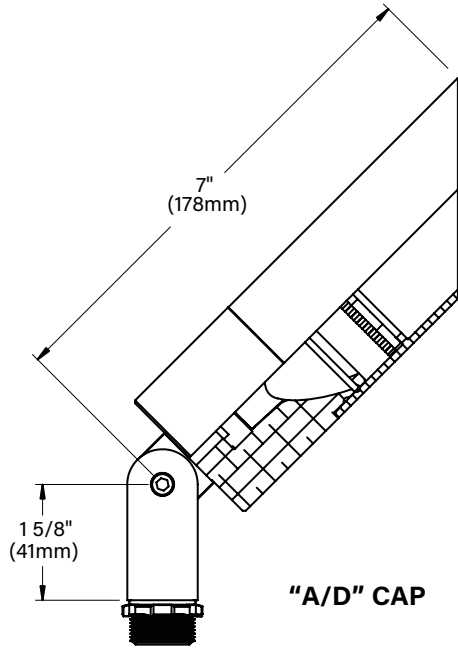

**A/D CAP**

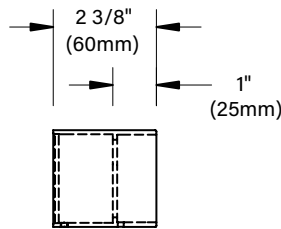

**B/E CAP**

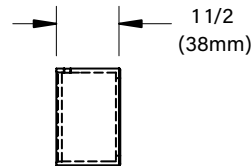

**C CAP**

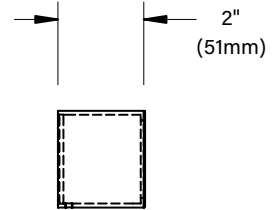

**F CAP**

**STANDARD FINISHES**



**PREMIUM FINISHES**

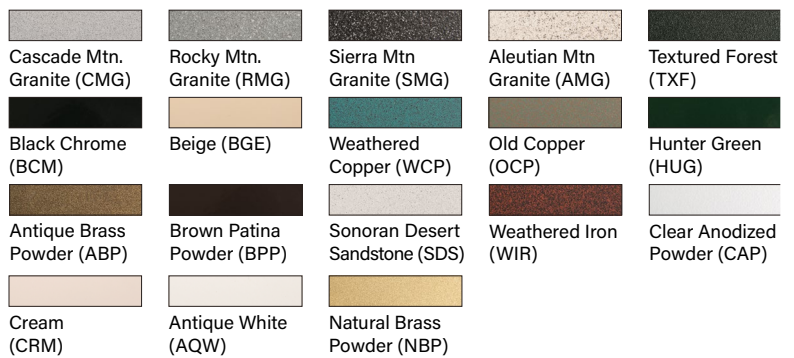





[Click Here](#) to view larger, full-color swatches of all available finishes on our website.

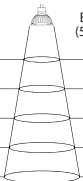

By SORAA™

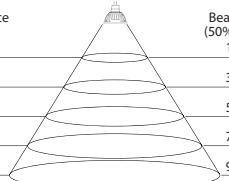
# MR16 LED LAMP

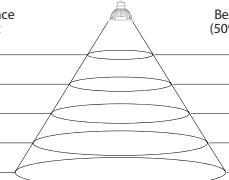
<p><b>B-K Lamp # 359</b>            Base: GU5.3 Bi-Pin            Input Voltage: 12V            CCT: 2700K            Beam: 10° Spot</p>	<p>Mfg. #: MR16-            SM16-07-10D-827-H1            Wattage: 7.5W            Lamp Efficacy: 77 (Lm/W)            Rated Life: 35,000 hrs</p>	<p>CBCP (cd): 8000            CRI: &gt;90            Power Factor: 0.92            Dimmable: Yes            Lumens: 575</p>	 <table border="1"> <thead> <tr> <th>Distance feet</th> <th>Beam Dia. (50% CBCP)</th> <th>Footcandles</th> </tr> </thead> <tbody> <tr><td>3'</td><td>0.5'</td><td>634</td></tr> <tr><td>6'</td><td>1.0'</td><td>160</td></tr> <tr><td>9'</td><td>1.6'</td><td>69</td></tr> <tr><td>12'</td><td>2.1'</td><td>40</td></tr> <tr><td>15'</td><td>2.6'</td><td>23</td></tr> </tbody> </table>	Distance feet	Beam Dia. (50% CBCP)	Footcandles	3'	0.5'	634	6'	1.0'	160	9'	1.6'	69	12'	2.1'	40	15'	2.6'	23
Distance feet	Beam Dia. (50% CBCP)	Footcandles																			
3'	0.5'	634																			
6'	1.0'	160																			
9'	1.6'	69																			
12'	2.1'	40																			
15'	2.6'	23																			
<p><b>B-K Lamp # 361</b>            Base: GU5.3 Bi-Pin            Input Voltage: 12V            CCT: 2700K            Beam: 25° Narrow Flood</p>	<p>Mfg. #: MR16-            SM16-07-25D-827-H1            Wattage: 7.5W            Lamp Efficacy: 80 (Lm/W)            Rated Life: 35,000 hrs</p>	<p>CBCP (cd): 3170            CRI: &gt;90            Power Factor: 0.92            Dimmable: Yes            Lumens: 600</p>	 <table border="1"> <thead> <tr> <th>Distance feet</th> <th>Beam Dia. (50% CBCP)</th> <th>Footcandles</th> </tr> </thead> <tbody> <tr><td>3'</td><td>1.3'</td><td>251</td></tr> <tr><td>6'</td><td>2.7'</td><td>63</td></tr> <tr><td>9'</td><td>4.0'</td><td>27</td></tr> <tr><td>12'</td><td>5.3'</td><td>16</td></tr> <tr><td>15'</td><td>6.7'</td><td>9</td></tr> </tbody> </table>	Distance feet	Beam Dia. (50% CBCP)	Footcandles	3'	1.3'	251	6'	2.7'	63	9'	4.0'	27	12'	5.3'	16	15'	6.7'	9
Distance feet	Beam Dia. (50% CBCP)	Footcandles																			
3'	1.3'	251																			
6'	2.7'	63																			
9'	4.0'	27																			
12'	5.3'	16																			
15'	6.7'	9																			
<p><b>B-K Lamp # 362</b>            Base: GU5.3 Bi-Pin            Input Voltage: 12V            CCT: 2700K            Beam: 36° Flood</p>	<p>Mfg. #: MR16-            SM16-07-36D-827-H1            Wattage: 7.5W            Lamp Efficacy: 80 (Lm/W)            Rated Life: 35,000 hrs</p>	<p>CBCP (cd): 1550            CRI: &gt;90            Power Factor: 0.92            Dimmable: Yes            Lumens: 600</p>	 <table border="1"> <thead> <tr> <th>Distance feet</th> <th>Beam Dia. (50% CBCP)</th> <th>Footcandles</th> </tr> </thead> <tbody> <tr><td>3'</td><td>1.9'</td><td>119</td></tr> <tr><td>6'</td><td>3.9'</td><td>30</td></tr> <tr><td>9'</td><td>5.8'</td><td>13</td></tr> <tr><td>12'</td><td>7.8'</td><td>7</td></tr> <tr><td>15'</td><td>9.7'</td><td>4</td></tr> </tbody> </table>	Distance feet	Beam Dia. (50% CBCP)	Footcandles	3'	1.9'	119	6'	3.9'	30	9'	5.8'	13	12'	7.8'	7	15'	9.7'	4
Distance feet	Beam Dia. (50% CBCP)	Footcandles																			
3'	1.9'	119																			
6'	3.9'	30																			
9'	5.8'	13																			
12'	7.8'	7																			
15'	9.7'	4																			
<p><b>B-K Lamp # 363</b>            Base: GU5.3 Bi-Pin            Input Voltage: 12V            CCT: 3000K            Beam: 10° Spot</p>	<p>Mfg. #: MR16-            SM16-07-10D-830-H1            Wattage: 7.5W            Lamp Efficacy: 80 (Lm/W)            Rated Life: 35,000 hrs</p>	<p>CBCP (cd): 8400            CRI: &gt;90            Power Factor: 0.92            Dimmable: Yes            Lumens: 600</p>	 <table border="1"> <thead> <tr> <th>Distance feet</th> <th>Beam Dia. (50% CBCP)</th> <th>Footcandles</th> </tr> </thead> <tbody> <tr><td>3'</td><td>0.5'</td><td>666</td></tr> <tr><td>6'</td><td>1.0'</td><td>168</td></tr> <tr><td>9'</td><td>1.6'</td><td>72</td></tr> <tr><td>12'</td><td>2.1'</td><td>42</td></tr> <tr><td>15'</td><td>2.6'</td><td>24</td></tr> </tbody> </table>	Distance feet	Beam Dia. (50% CBCP)	Footcandles	3'	0.5'	666	6'	1.0'	168	9'	1.6'	72	12'	2.1'	42	15'	2.6'	24
Distance feet	Beam Dia. (50% CBCP)	Footcandles																			
3'	0.5'	666																			
6'	1.0'	168																			
9'	1.6'	72																			
12'	2.1'	42																			
15'	2.6'	24																			
<p><b>B-K Lamp # 365</b>            Base: GU5.3 Bi-Pin            Input Voltage: 12V            CCT: 3000K            Beam: 25° Narrow Flood</p>	<p>Mfg. #: MR16-            SM16-07-25D-830-H1            Wattage: 7.5W            Lamp Efficacy: 84 (Lm/W)            Rated Life: 35,000 hrs</p>	<p>CBCP (cd): 3300            CRI: &gt;90            Power Factor: 0.92            Dimmable: Yes            Lumens: 630</p>	 <table border="1"> <thead> <tr> <th>Distance feet</th> <th>Beam Dia. (50% CBCP)</th> <th>Footcandles</th> </tr> </thead> <tbody> <tr><td>3'</td><td>1.3'</td><td>266</td></tr> <tr><td>6'</td><td>2.7'</td><td>67</td></tr> <tr><td>9'</td><td>4.0'</td><td>29</td></tr> <tr><td>12'</td><td>5.3'</td><td>17</td></tr> <tr><td>15'</td><td>6.7'</td><td>10</td></tr> </tbody> </table>	Distance feet	Beam Dia. (50% CBCP)	Footcandles	3'	1.3'	266	6'	2.7'	67	9'	4.0'	29	12'	5.3'	17	15'	6.7'	10
Distance feet	Beam Dia. (50% CBCP)	Footcandles																			
3'	1.3'	266																			
6'	2.7'	67																			
9'	4.0'	29																			
12'	5.3'	17																			
15'	6.7'	10																			
<p><b>B-K Lamp # 366</b>            Base: GU5.3 Bi-Pin            Input Voltage: 12V            CCT: 3000K            Beam: 36° Flood</p>	<p>Mfg. #: MR16-            SM16-07-36D-830-H1            Wattage: 7.5W            Lamp Efficacy: 84 (Lm/W)            Rated Life: 35,000 hrs</p>	<p>CBCP (cd): 1650            CRI: &gt;90            Power Factor: 0.92            Dimmable: Yes            Lumens: 630</p>	 <table border="1"> <thead> <tr> <th>Distance feet</th> <th>Beam Dia. (50% CBCP)</th> <th>Footcandles</th> </tr> </thead> <tbody> <tr><td>3'</td><td>1.9'</td><td>125</td></tr> <tr><td>6'</td><td>3.9'</td><td>32</td></tr> <tr><td>9'</td><td>5.8'</td><td>14</td></tr> <tr><td>12'</td><td>7.8'</td><td>8</td></tr> <tr><td>15'</td><td>9.7'</td><td>5</td></tr> </tbody> </table>	Distance feet	Beam Dia. (50% CBCP)	Footcandles	3'	1.9'	125	6'	3.9'	32	9'	5.8'	14	12'	7.8'	8	15'	9.7'	5
Distance feet	Beam Dia. (50% CBCP)	Footcandles																			
3'	1.9'	125																			
6'	3.9'	32																			
9'	5.8'	14																			
12'	7.8'	8																			
15'	9.7'	5																			

**B-K LIGHTING**

MADE IN THE USA

559.438.5800 | INFO@BKLIGHTING.COM | BKLIGHTING.COM

THIS DOCUMENT CONTAINS PROPRIETARY INFORMATION OF B-K LIGHTING, INC. AND ITS RECEIPT OR POSSESSION DOES NOT CONVEY ANY RIGHTS TO REPRODUCE, DISCLOSE ITS CONTENTS, OR TO MANUFACTURE, USE OR SELL ANYTHING IT MAY DESCRIBE. REPRODUCTION, DISCLOSURE OR USE WITHOUT SPECIFIC WRITTEN AUTHORIZATION OF B-K LIGHTING, INC. IS STRICTLY FORBIDDEN.

DATE: \_\_\_\_\_ PROJECT: \_\_\_\_\_ TYPE: \_\_\_\_\_

ACCESSORIES (Configure separately)

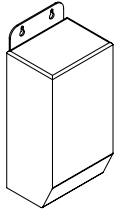

TR Series

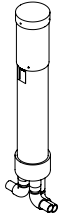

Power Pipe

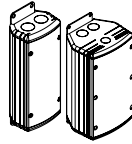

UPMRM

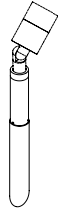

Power Pipe

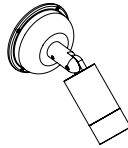

Power Canopy

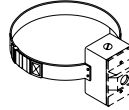

Tree Strap



Stems

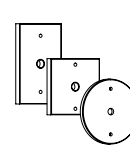

Canopies

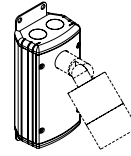

UPM

SPECIFICATIONS

ELECTRICAL	WATTAGE	7.5W
	SOCKET	Specification grade, ceramic body lamp holder. GU5.3 base. Nickel allows contacts and heat resistant, spring loaded, stainless steel lamp retaining clips.
	WIRING	Teflon® coated wire, 18AWG, 600V, 250° C rated and certified to UL 1659 standard.
	REMOTE TRANSFORMER	For use with 12 VAC remote transformer.
PHYSICAL	MATERIALS	Furnished in copper-free aluminum (6061-T6).
	BODY	Unibody design with enclosed, water-proof wireway and integral heat sink is fully machined from solid billet.
	KNUCKLE	LOCK Knuckle is integral to the body and features an interior taper machined from solid billet and a second, reverse angle taper allowing full 180° vertical adjustment without the use of aim-limiting serrated teeth. High temperature, silicone 'O' Ring provides water-tight seal and compressive resistance to maintain fixture position. Design withstands 73 lbs. static load prior to movement for optical alignment with a ½" pipe thread for mounting. Optional 360SL provides biaxial source control with 360° horizontal rotation in addition to vertical adjustment.
	CAP	Fully machined and accommodates one (1) lens or louver media.
	LENS	Shock resistant, tempered, glass lens is factory adhered to fixture cap and provides hermetically sealed optical compartment.
	SOURCE	For use with 50W maximum, bi-pin MR16 lamps (by others*). Not for use with IR technology lamps. *Except GE Light Q42MR16/C/VNSP9 (EZY).
	HARDWARE	Tamper-resistant, stainless steel hardware. LOCK aiming screw is black oxide treated for additional corrosion resistance.
	FINISH	StarGuard, our 15-stage chromate-free process cleans and conversion coats aluminum components prior to application of Class 'A' TGIC polyester powder coating and is RoHS compliant.
	WARRANTY	5-year limited warranty.
CERTIFICATION & LISTING	ITL tested to IESNA LM-79. UL Listed. Certified to CAN/CSA/ANSI Standards. RoHS compliant. Suitable for indoor or outdoor use, in wet locations, and for installation within 4' of the ground. IP66 Rated. Made in the USA with sustainable processes.	