

DATE:	PROJECT:	TYPE:
-------	----------	-------

CATALOG NUMBER LOGIC:

**CATALOG NUMBER LOGIC**

Example: RM - D23ARC - WHP - MT

MATERIAL

Aluminum

SERIES

RM - Remote Wall Mount (NEMA 3R)

DRIVER TYPE*

D23 - 23W Dimming Driver (Standard Dimming 1-100%)

D34 - 34W Dimming Driver (Standard Dimming 1-100%)

D23ARC - 23W Dimming Driver (Architectural Dimming 0.1-100%)

D34ARC - 34W Dimming Driver (Architectural Dimming 0.1-100%)

FINISH (See page 2 for full-color swatches)

Standard Finishes (BZP, BZW, BLP, BLW, WHP, WHW, SAP, VER)

Premium Finish (ABP, AMG, AQW, BCM, BGE, BPP, CAP, CMG, CRM, HUG, NBP, OCP, RMG, SDS, SMG, TXF, WCP, WIR)

(Also available in RAL Finishes. See submittal SUB-1439-00)

INPUT VOLTAGE

MT - 120-277 VAC

**For use with 0-10 dimmer. Driver wattage must match fixture wattage.*

DATE: _____ PROJECT: _____ TYPE: _____

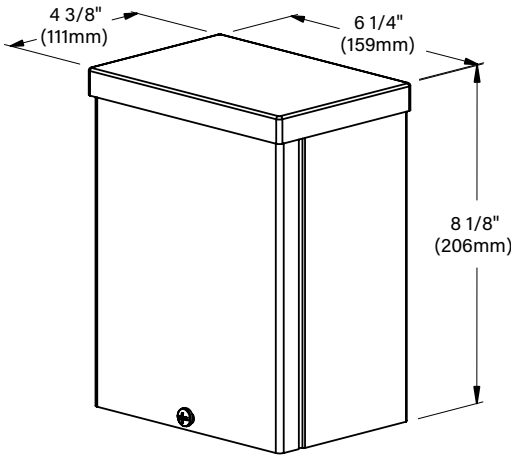

SIDE VIEW

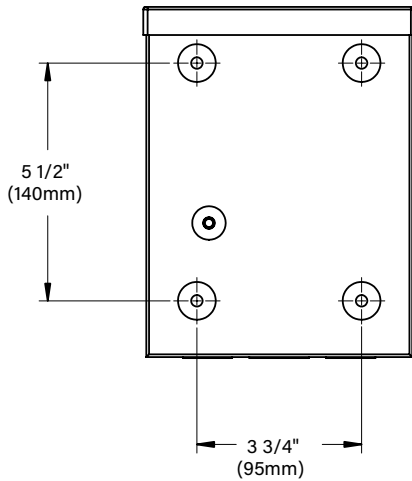

BACK VIEW

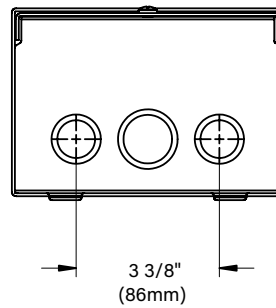

END VIEW

⚠ REMOTE WIRING

LED Driver

Remote driver installations require inter-connected wiring between the LED and driver (by others). Drivers have specific wiring requirements between these components. Driver manufacturers regularly recommend the following wiring details for such installations:

- Do not exceed 50 foot overall wiring distance using 12 gauge copper wire.

Failure to comply with specific wiring requirements will void product warranty.

STANDARD FINISHES



PREMIUM FINISHES

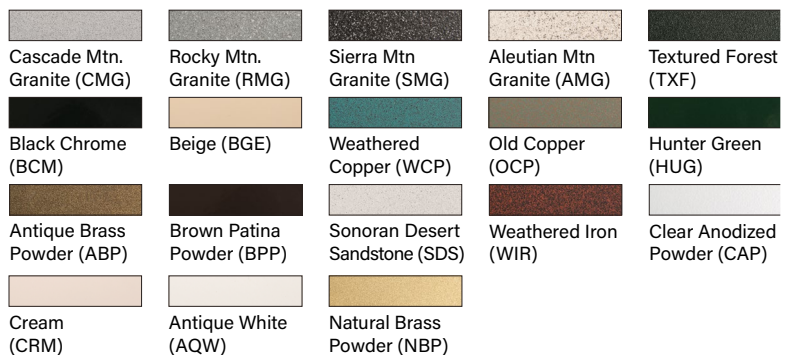



[Click Here](#) to view larger, full-color swatches of all available finishes on our website.

DATE:	PROJECT:	TYPE:
-------	----------	-------

ACCESSORIES (Configure separately)

SPECIFICATIONS

Electrical	WIRING / CONNECTORS	Teflon® coated wire, 18 gauge, 600V, 250°C rated and certified to UL1659 standard. Pre-wired and labeled terminal strip.
	DRIVER (23-34W)	One (1) 700mA/1.05A (D23, D34) Class A, constant current driver. 120-277VAC (nominal) primary input voltage. 50/60Hz. >0.90 Power Factor, <10.0A in-rush current, .20%THD (nominal at 120VAC full load). Output overvoltage, over-current, and short circuit protection with auto recovery. EMC: FCC47CFR Part 15 Class B compliant. Dimming driver for use with standard 0-10V dimmers and switch controls. Refer to driver electrical data for dimming range..
PHYSICAL	INSTALLATION	Nema 3R, surface mount design. For use with remote fixture (specified separately).
	HOUSING	Steel construction with screw cover. Front access for ease of installation and inspection. Two (2) bottom entry, 3/4" conduit knockouts.
	FINISH	StarGuard, our 15-stage, chromate-free process cleans and conversion coats aluminum components prior to application of Class 'A' TGIC polyester power coating and is RoHS compliant.
	WARRANTY	5-year limited warranty.
	CERTIFICATION & LISTING	NEMA 3R Enclosure. UL Listed. Certified to CAN/CSA/ANSI Standards. RoHS compliant. Made in USA with sustainable processes.
  		

B-K LIGHTING

MADE IN THE USA

559.438.5800 | INFO@BKLIGHTING.COM | BKLIGHTING.COM

DATE:	PROJECT:	TYPE:
-------	----------	-------

CATALOG NUMBER LOGIC:

**CATALOG NUMBER LOGIC**

Example: DRM - D23ARC - SAP - MT

MATERIAL

Aluminum

SERIES

DRM - Dual Remote Wall Mount (NEMA 3R)

DRIVER TYPE*

D23 - (2) 23W Dimming Drivers (Standard Dimming 1-100%)

D34 - (2) 34W Dimming Drivers (Standard Dimming 1-100%)

D23ARC - (2) 23W Dimming Drivers (Architectural Dimming 0.1-100%)

D34ARC - (2) 34W Dimming Drivers (Architectural Dimming 0.1-100%)

FINISH (See page 2 for full-color swatches)

Standard Finishes (BZP, BZW, BLP, BLW, WHP, WHW, SAP, VER)

Premium Finish (ABP, AMG, AQW, BCM, BGE, BPP, CAP, CMG, CRM, HUG, NBP, OCP, RMG, SDS, SMG, TXF, WCP, WIR)

(Also available in RAL Finishes. See submittal SUB-1439-00)

INPUT VOLTAGE

MT - 120-277 VAC

**For use with 0-10 dimmer. Driver wattage must match fixture wattage.*

DATE: _____ PROJECT: _____ TYPE: _____

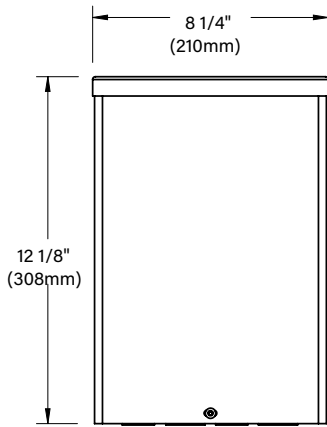

FRONT VIEW

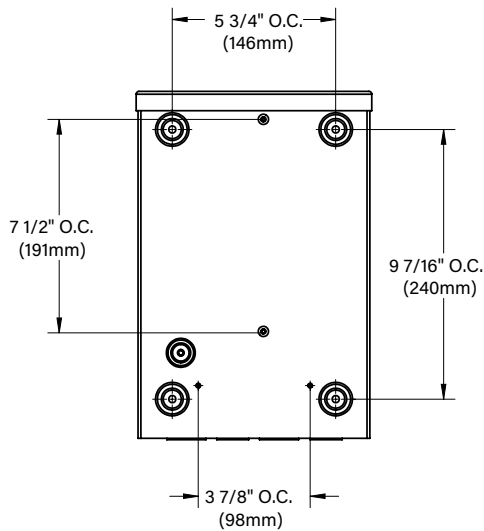

BACK VIEW

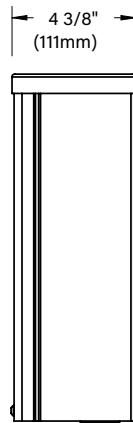

SIDE VIEW

⚠ REMOTE WIRING

LED Driver

Remote driver installations require inter-connected wiring between the LED and driver (by others). Drivers have specific wiring requirements between these components. Driver manufacturers regularly recommend the following wiring details for such installations:

- Do not exceed 50 foot overall wiring distance using 12 gauge copper wire.

Failure to comply with specific wiring requirements will void product warranty.

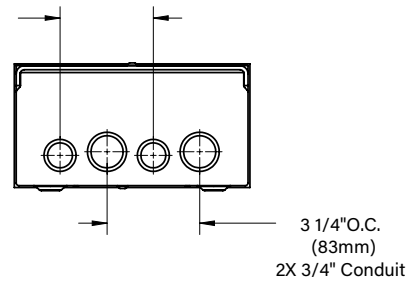

END VIEW

STANDARD FINISHES



PREMIUM FINISHES





[Click Here](#) to view larger, full-color swatches of all available finishes on our website.

DATE:	PROJECT:	TYPE:
-------	----------	-------

ACCESSORIES (Configure separately)

SPECIFICATIONS

Electrical	WIRING / CONNECTORS	Teflon® coated wire, 18 gauge, 600V, 250°C rated and certified to UL1659 standard. Pre-wired and labeled terminal strip.
	DRIVER (23-34W)	Two (2) 700mA/1.05A (D23, D34) Class A, constant current drivers. 120-277VAC (nominal) primary input voltage. 50/60Hz. >0.90 Power Factor, 15.0A in-rush current, .20%THD (nominal at 120VAC full load). Output overvoltage, over-current, and short circuit protection with auto recovery. EMC: FCC47CFR Part 15 Class B compliant. Dimming driver for use with standard 0-10V dimmers and switch controls. Refer to driver electrical data for dimming range..
PHYSICAL	INSTALLATION	Nema 3R, surface mount design. For use with remote fixtures (specified separately).
	HOUSING	Steel construction with screw cover. Front access for ease of installation and inspection. Two (2) bottom entry, 3/4" conduit knockouts.
	FINISH	StarGuard, our 15-stage, chromate-free process cleans and conversion coats aluminum components prior to application of Class 'A' TGIC polyester power coating and is RoHS compliant.
	WARRANTY	5-year limited warranty.
	CERTIFICATION & LISTING	NEMA 3R Enclosure. UL Listed. Certified to CAN/CSA/ANSI Standards. RoHS compliant. Made in USA with sustainable processes.
  		

B-K LIGHTING
MADE IN THE USA

 559.438.5800 | INFO@BKLIGHTING.COM | BKLIGHTING.COM